

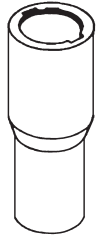

## ANTIQUE AUTO PARTS, INC.

### ECONOMY GAS TANK NECKS



119-1620



119-1644

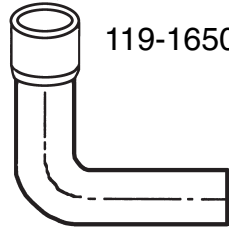

119-1650

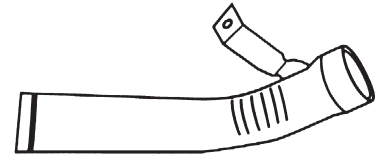

119-1670

Part No.	Year	Description
119-1620		<b>Ford Style Universal Neck.</b> Accepts Ford locking gas cap, or stock 1932-48 Ford cap
119-1643	1933-34	<b>Neck</b> – Fits 1933-34 Ford Sedan Delivery and Station Wagon
119-1644	1933-34	<b>Pickup and Victoria Gas Neck.</b> Fits our tanks. Use 2" connector hose
119-1646	1935-37	<b>Pickup Gas Neck.</b> Fits our tanks. Use 2" connector hose
119-1650	1935-37	<b>Passenger Gas Neck</b>
119-1653	1938	<b>Neck</b> Fits all except: (2-door DLX, 4-door DLX)
119-1655	1938-40	<b>Neck</b> Fits 38 (2-door DLX) (4-door DLX) 39-40 All Models
119-1670	1942-48	<b>Passenger Gas Neck</b>

### STAINLESS STEEL GAS TANK NECKS

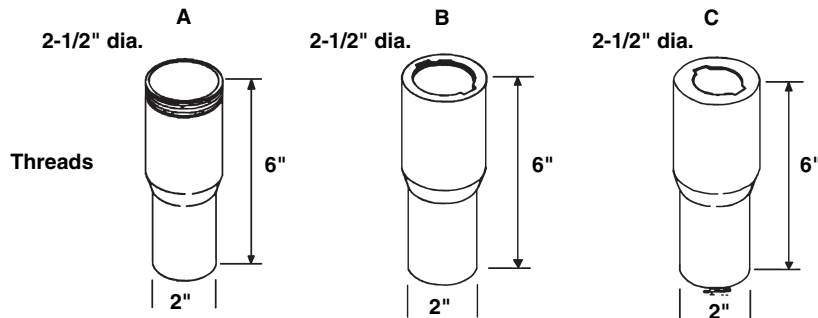

119-1610-SR

119-1620-SR

419-1610-SR

Part No.	Description
119-1610-SR	A. <b>Threaded Neck.</b> Accepts our leak proof cap 119-2440. Requires vent
119-1620-SR	B. <b>Ford Style Universal Neck.</b> Accepts Ford locking gas cap, or stock 1932-48 Ford cap
419-1610-SR	C. <b>Chevrolet Style Universal.</b> Accepts Chevrolet locking gas cap or stock cap

CALL FOR CURRENT PRICING



# ROCK VALLEY

ANTIQUUE AUTO PARTS, INC.



## STAINLESS STEEL GAS TANK NECKS

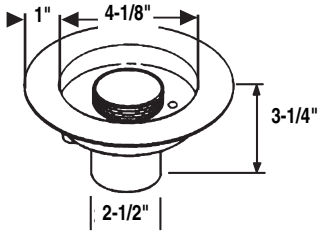

119-1630-SR

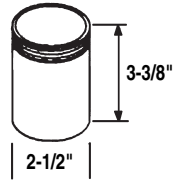

119-1640-SR

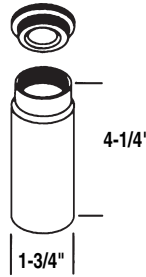

119-1642-SR

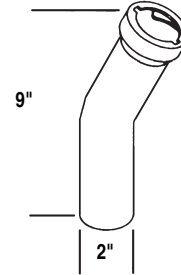

119-1644-SR

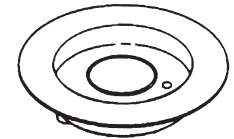

119-1645-SR

119-1630-SR

**Floor Mount Neck.** Accepts our threaded cap 119-2440 and requires vent. Cap sits lower than mount flange, so you can put a cover over this neck. Ideal for trunk floors, pick-up beds and Sedan delivery floors.

119-1640-SR

**Threaded Neck.** Accepts our threaded cap 119-2440 and requires vent

119-1641-SR

**Aluminum Filler Cap and Weld** in Steel Bung used on Mini Necks

119-1642-SR

**Universal Mini Threaded Neck and Cap.** For use behind small gas door, gas opening 1 1/4" dia., requires vent

119-1643-SR

**Neck**—Fits 1933-34 Ford Sedan Delivery, Station Wagon

119-1644-SR

**Pickup and Victoria Gas Neck.** Fits our tanks. 1933-34 - Use 2" connector hose

119-1645-SR

**Recessed Cup** with drain, the center hole is 2-1/2" dia. This cup can be used in a pickup body or truck floor to slide over one of our threaded necks

119-1646-SR 1935-37 **Pickup Gas Neck.** Fits our tanks.

Use 2" connector hose

119-1650-SR 1935-37 **Neck** (Fits all models - cars)

119-1653-SR 1938 **Neck** (Fits all except: 2-door DLX, 4-door DLX)

119-1655-SR 1938-40 **Neck** (Fits 38 2-door DLX, 4-door DLX)  
39-40 All Models

119-1670-SR 1942-48 **Passenger Gas Neck**

Made of 304 stainless, a copy of the original, they will accept a 1932-48 Ford gas cap. Either locking or non-locking.

### CUSTOM GAS NECKS

WE BUILD CUSTOM GAS NECKS TO YOUR SPECIFICATIONS FROM A DRAWING OR SAMPLE.

CALL FOR CURRENT PRICING